



Detailed instructions for use of Gudrutis Super-G Active

Detailed instructions for use of the Super-G app



CONTENTS

About the watch-phone	3
Watch model and main functions	3
Technical parameters of Gudrutis Super G Active	3
Get to know the your watch-phone	4
Device set	4
Watch housing and display	4
Getting ready	5
SIM card	5
Charging and turning of the watch	6
Watch menu	7
Secret Watch menu	7
Controlling the watch with Super-G app	8
How to install the app?	8
How to register and add Gudrutis?	9
More features of Super-G	12
Calls	12
Messages	12
Health	12
Child's location	12
Multiple devices	13
More settings	13
Your profile and settings	13
Password changing	13
Password reminder	14
Child profile and settings	16
Warranty and servicing	18
Questions? Contact us!	18

About the watch-phone

Watch model and main functions

Gudrutis Super-G Active

Technical parameters of Gudrutis Super G Active

- Calls, voice and text messages to the watch;
- Calls and voice messages from the watch;
- 10 contact book;
- 1.3" IPS colour touch screen;
- 240 * 240 screen resolution;
- CPU: MTK;
- Ultra-low power dissipation;
- Battery operation: up to 3 days*;
- Nano SIM card;
- Positioning**;
- Alarm;
- SOS help button;
- 'Not to disturb' mode;
- Low battery messages;
- Heart rate measurement;
- Pedometer
- Weather information (real time);

* Battery life depends on the watch update settings you choose, the way you use the watch, and natural wear.

** Navigation outdoors according to WIFI and GPS, indoors – WIFI and CELLS (the position of the operators' GSM towers). Positioning error is possible depending on the communication operator, positioning signal and other technical conditions. **This is not an exact location positioning device!**

!Attention! Calls and data transfer require a 2G SIM card with a call plan, SMS and mobile data plan (about 200 MB/month).

Attention! Danger! We do not recommend immersing the device in water/liquids or pouring water/liquids directly onto the housing. If the watch case is wet or mechanically damaged, the warranty shall be void.

Get to know the your watch-phone

Device set

Make sure the box contains all components:

- watch-phone
- charging unit
- 1 extra shorter silicone bracelet
- 1 extra SIM card cover
- start guide



Watch housing and display

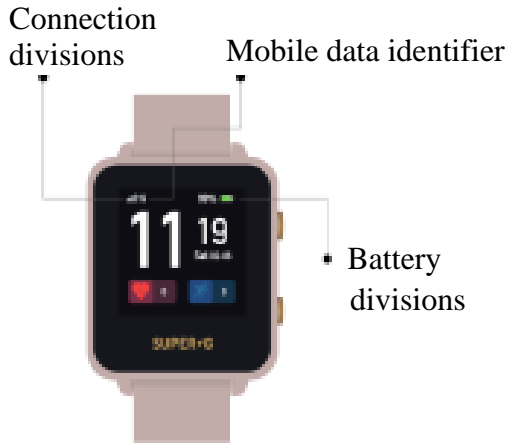

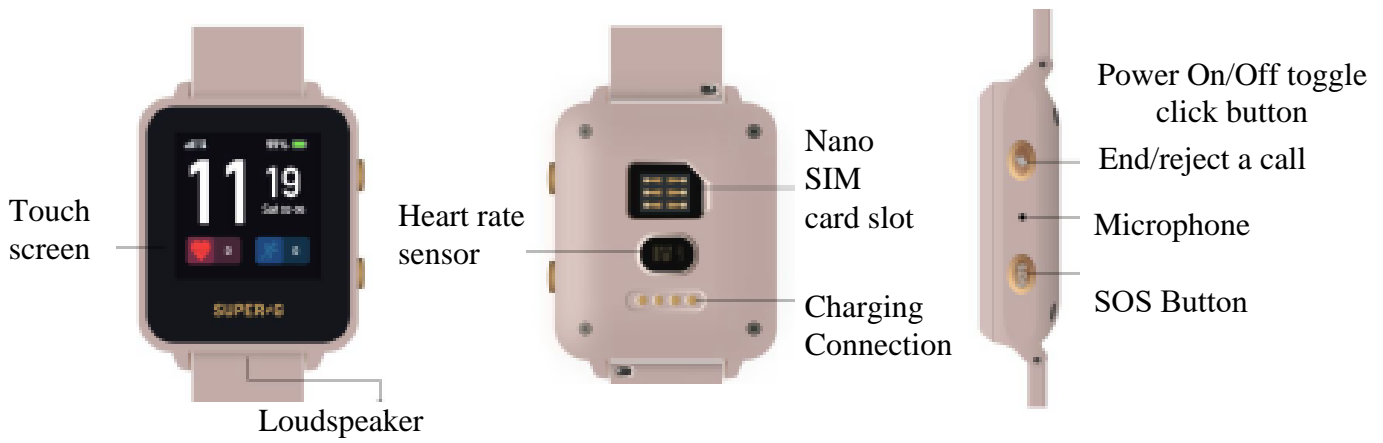

Watch screen control



Swipe left to navigate between the watch functions



Click on the icon to select the required function

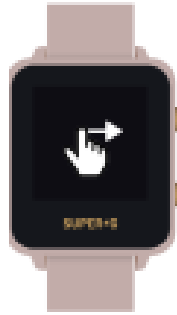

Swipe right to return to the menu or exit a function

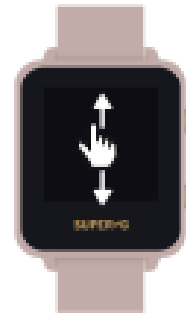

Swipe up to view your device's IMEI. Swipe down to check the weather

Getting ready

SIM card

Insert the SIM* card into the watch as shown in the picture:

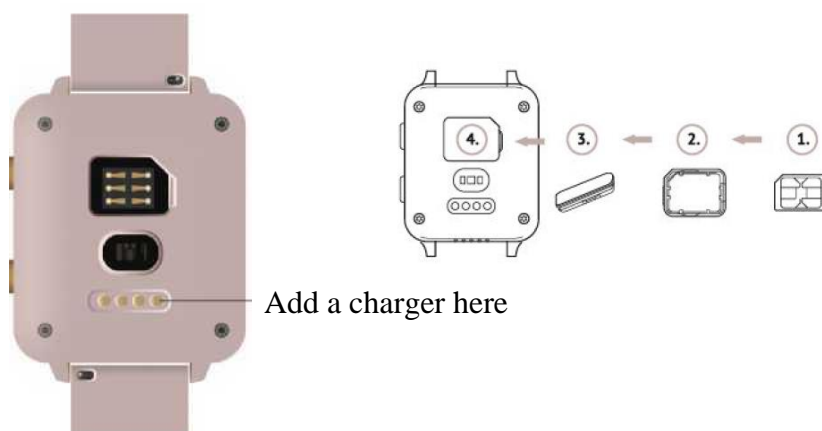

- Make sure the SIM card has no PIN code (you can remove it by inserting the SIM card into the mobile phone);
- Make sure the device is off
- Lift the SIM card cover;
- Carefully insert the card into the cover;
- Insert the cover into the watch at a 45° angle;

***Important!** The watch only supports 2G SIM cards. The mobile data, chat and SMS plan must be activated on the SIM card. We recommend to have about 200 MB of mobile data per month.

Charging and turning of the watch

After successfully inserting the SIM card, charge the watch:

- Attach the magnetic charger to the back of the watch;
- Make sure the charger cable is straight and securely fastened;
- Leave the device on a hard, stationary surface;
- You should see the battery charging icon on the screen;
- Charge the watch until you see that the battery is fully charged!*
- Turn on the Super-G Active watch by pressing and holding the button on the side.

***Important!** You can charge the watches with a charger adapter that supports up to 5 V/1 A.

*Charging time 2-3 hr We recommend recharging every day before the watch-phone is completely discharged.

Watch menu

Swipe the touch screen from right to left to find the following menu items:

1. Address book:
 - o go in and click on a contact to make a call
 - o to end the call, press the power key on the watch screen or the button with the lightning bolt symbol on the side
2. Pedometer:
 - o you will see how far and how many steps have been walked, and approximately how many calories have been burned
3. Heart rate:
 - o you will see the current heart rate and one previous measurement
4. Voice messages (chats):
 - o go in and click on the received message to listen it
 - o click the "Microphone icon" and speak; release to send the message
5. Text messages:
 - o come to read the last received text message
6. Settings:
 - o Language (here you can select the language of the device)
 - o Style (here you can choose from two available watch styles).
 - o Volume and brightness (you can adjust the volume and brightness of the watch)
7. Swipe from top to bottom on the home screen to see the weather in real time.
8. Swipe up from the bottom of the home screen to see the IMEI number and QR code.

Watch secret menu

The watch's secret menu is activated by tapping the QR code 10 times. You will find the following items in the secret menu (secret menu in English):

1. Power off
 - o Switch off the appliance by pressing the 'Power off' button.
2. Music Test
 - o Selecting this test starts playing music for checking the speaker function.
3. Factory Test
 1. Here you will find the operating system version, the release date of the operating system version, the IMEI code, the server name, the MNC and MCC codes of the SIM card.
 2. Here you will find information on how many Wi-Fi modems, GPS satellites, mobile internet towers the device sees, and information on how the heart rate monitor function.
 3. Here you will find the speaker test.
 4. Here you will find a vibration test. Touch the screen to vibrate the watch.
 5. Microphone test. Touch and hold the screen. After the vibration the sound will be recorded. Release your finger from the screen to hear what the watch has recorded.
 6. Button test. Press the buttons one by one. If the buttons are functioning properly, you will see the messages "OK" on the screen.
 7. Off function. Touch the screen to turn off the watch.
 8. Watch language change function. Touch the screen to change the to the language

indicated on the screen.

9. Emergency call function. When you touch the screen, the watch calls the general emergency number 112.

10. "Restore" – factory parameter reset function. Touching the screen will restore the factory settings.

4. Tp test

1. Touch screen check function. Select this test and swipe your finger across the screen to see if the screen is sensitive in all places.

Controlling the watch with Super-G app

How to install the app?

- You can find the Super-G app on Google Play and the App Store;
- Download the app to your phone or other smart device;
- Register the device in the app by pressing the menu function - **"Add a device"**:
 - a. Scan the QR code on the watch;
 - b. Or enter the IMEI/ID number you will find in the watch (or on the packaging)
- Follow the instructions in the app to set the parameters.

The watch can be controlled from several devices.

Should you have any questions, contact our team.



How to register and add Gudrutis?

1. Download the app, click "Start" and select your language.

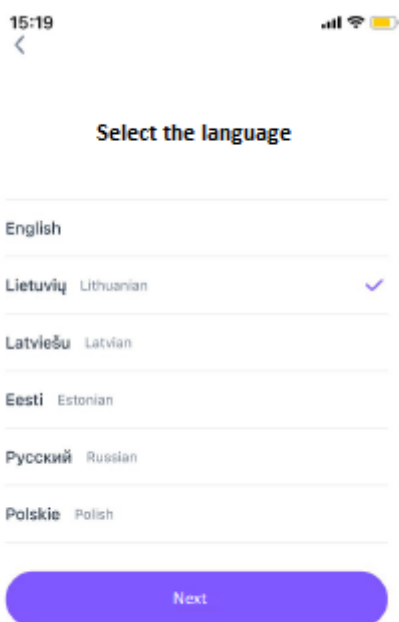
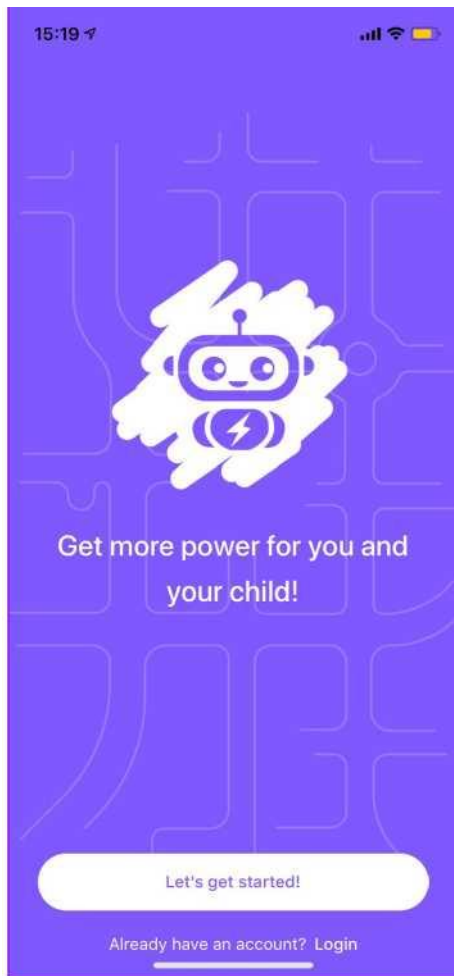

2. Scan the QR code on the watch or enter the IMEI code manually (you will find the code on



both the watch and the back of the box).

3. Enter your child information and your phone number.

Important! Allow access after you receive a notification about access to your phone's camera, photo gallery, location, and microphone. Otherwise, the app may not be fully functional.

14:34
<



Enter the child information



Child's first name

Watch phone number

Next

14:35
<



Add your phone number



First name

Telephone number

Next

You are connected!

More features of Super-G

Calls

How does it work?

Clicking on the call icon at the bottom will take you to a window with a call history.

To call the watch directly, press the phone icon. You can also call the watch directly from the address book.

To listen to the device, press the headset icon and select the phone number from which you want to listen the watch.

Messages

You will find a message icon in the bar at the bottom. Clicking it will take you to the message window.

In the window that opens, you can see incoming and outgoing voice and text messages.

Icons allow you to choose the type of message you want to send: voice or text: to send a voice message, click on the microphone icon, speak and release; To send a text message, click on the keyboard icon, enter the text, and press "Send". Messages will go directly to the watch.

In the app you can listen or read the messages received from Gudrutis.

Health

In the bottom bar you will find the selection – MORE. After selecting it, you will find the "Health" section.

In this section you can see information about steps taken, calories burned, and distance travelled.

Child's location

You will see the map in the main app window (or by clicking the first icon in the bottom menu bar). A circle with the child's picture shows the child's location. Click on the circle to see:

- preliminary device location information
- the date and time when the watch last sent the coordinates of the location
- device battery data
- Communication solutions used by the device to navigate during the last data transmission (WiFi, GPS or CELLS (this is the position of the operators' GSM towers))*
- directions to get to the location
- location refresh button. **

** The watch navigates outdoors according to WIFI and GPS, indoors – WIFI and CELLS (the position of the operators' GSM towers). Possible location error depending on the communication

operator, positioning signal and other technical conditions. **This is not an exact location positioning device!**

In the upper right corner of the main window you will find:

- map type selection
- map update
- location of your phone

Multiple devices

You can add and conveniently manage multiple watches in the app:

- go to the menu in the top left corner;
- Select "Watch List":
- click "+" in the upper right corner;
- scan the QR code on the watch (or on the box) or enter it manually;
- fill in the child information;
- the successfully added watch will appear in the app and in the watch list.

To track the location of a particular watch, make a call, send a message, or edit the settings, select the device in the main app window, below the map, by clicking on the jacket watch icon (photo, if you added it when registering the watch).

More settings

Your profile and settings

Password changing

- > To change the password, click the icon in the upper left corner of the main window;
- > Select "Change password"
- > Enter the old password;
- > Enter a new password;
- > Save;
- > Password is changed successfully.

Password reminder

If you forget your app login password:

- > Select the password reminder function;
- > Enter the email address you registered for the app.
- > Check your inbox on the same phone as your app.
- > In the incoming letter you will find a button with a link, click it (see the fig. below);
- > You will be forwarded to the password change window (see the fig.);
- > Change password and save it.

Super-G

Hello!

You are receiving this email because we received a password reset request for your account.

Reset Password

This password reset link will expire in 60 minutes.

If you did not request a password reset, no further action is required.

Regards,
Super-G

If you're having trouble clicking the "Reset Password" button, copy and paste the URL below into your web browser: <https://gudrutis.digitalaz.com/redirect/password/reset/bd69063da70d54242db713a8e496db814f66fbed16c4hc3fc67100c962d42bc8/174>

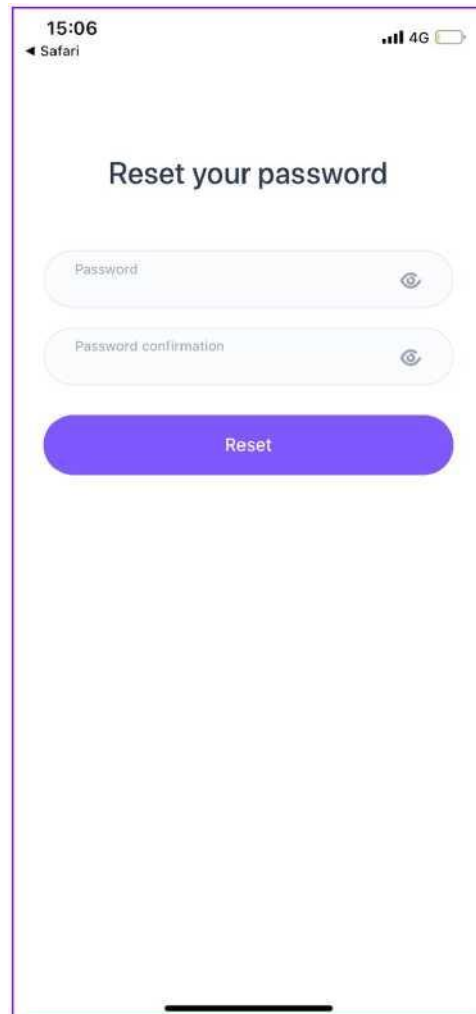
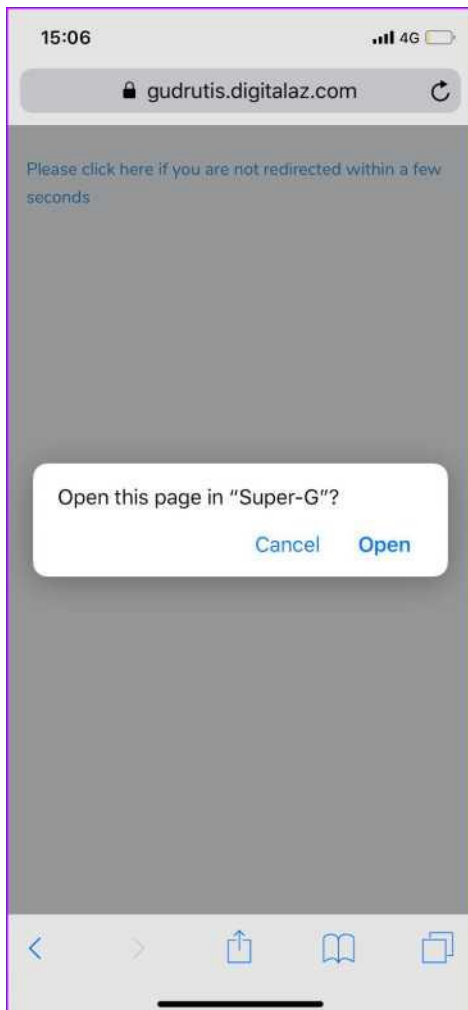

App language settings

- > To set the app language, click the icon in the upper left corner of the main window;
- > Choose "Language";
- > Select your language and save.

Your profile settings in the app

- > To edit your profile settings in the app, click the icon in the upper left corner of the main window;
- > Select "Profile settings";
- > Edit the settings and save them.

Child profile and settings

If you have more than one watch, first select the watch which settings you want to edit. Then in the bottom right corner of the menu bar, press "More" and go to the menu with additional functions and settings:

Address book.

- > To add contacts to the address book, select "Contacts"
- > Click the "+" in the upper right corner
- > Enter the contact name and phone number
- > You can add the new contact to SOS contacts (maximum 3 contacts)
- > To delete a contact, select the required contact, then click "Edit" and "Delete contact".
- > Added numbers will automatically appear on the watch.

Pedometer:

- > click on the pedometer icon to see the steps taken, distance and calories.
- Caution! Not all models of Gudrutis watches have pedometer and other health monitoring features.

Battery settings:

- > click on the battery icon to edit the settings;
 - > Standard mode: the map is automatically updated every 10 minutes.
 - > ECO mode (the map is automatically updated every 30 minutes)
 - > Battery saving mode (the map is automatically updated once an hour)
- N.B.: the selected mode shortens/extends the battery life accordingly. It is recommended to select the "Battery Saver" mode.

History:

- > click on the "History" icon to see the preliminary locations recorded by the current day's watch.
- > the displayed history is preliminary, depending on the location method (WiFi, GPS or CELLS (this is the position of the operators' GSM towers)). The watch sends the information at

a certain interval, therefore, the travel route is preliminary.

Alarm watch:

- > click the alarm icon to add an alarm or reminder;
- > press "+" to create a new alarm sounding time
- > enter a name (it will only be seen in the app)
- > set the time (alarm sounds repeatedly)
- > additionally, you can select automatic alarm/reminder repetition
- > Save. The alarm will sound at the scheduled time on the watch.

Not to disturb mode

When you select this mode, you lock the watch – the screen will not function and will not respond to touch, the watch will not have a call signal. To set the "Do not disturb" mode:

- > click the no-interference mode icon;
- > press "+" to activate the "Do not disturb" mode
- > enter a name (it will only be seen in the app)
- > set the start and the end times, and save.

Ringtone

In the Super G Active watch, you can select three ringing statuses: ringing, vibrating, or silent mode.

Additional settings:

- switching off the device remotely;
- reloading the device remotely.
- time and date.

Warranty and servicing

Gudrutis products are covered by 2 year warranty.

The warranty does not apply to failures caused by mechanical damage, moisture or improper use. Wear and tear of the battery, other parts of the housing over time is not covered by the warranty.

This device is not a precision positioning device.

The main function of the watch-phone is incoming and outgoing calls. Positioning is an additional feature, its accuracy may depend on technical conditions and circumstances.

Attention! Danger! We do not recommend immersing the device in water/liquids or pouring water/liquids directly onto the housing. If the watch case is wet or mechanically damaged, the warranty shall be void.

More information about the warranty, warranty limitations and other up-to-date information can be found here: <https://help.super-g.watch/lt/support/home>

Official warranty is provided by

UAB Promo vero

Company registration number 304041104

VAT code LT100009506518
Konstitucijos pr. 26, 08105
Vilnius LT643500010002023659

Questions? Contact us!

Tel. +370 614 77866

E-mail labas@gudrutis.lt

